

Micro-Pro Line

airofog[®]
USA



600-000-110

Airofog USA
Precision
Gel Gun

Airofog Gel Gun is designed by the theory of negative pressure. Gel bait is sucked out through the gun instead of being pushed out in the traditional way by a plunger, ensures an accurate amount of each bait placement and avoids an overflow of gel bait. By adjusting the wheel regulator, 5 different doses can be selected to meet a variety of demand. Adapts to most 30g/35g gel cartridges.

Safety

- Keep out of reach of children.
- Never inject the metal tip/needle of the gun into electric outlets.
- Not to touch the exposed cables or electric outlets with the gun's metal part especially in the thunder weather.
- Follow the manufacturer's instruction for the safety of gel cartridge.

Getting Started

Step 1: Remove the closure (18) and place a stainless steel or plastic needle (19).

Step 2: Remove the tip cover of gel cartridge, then insert the cartridge into the gun compartment by pushing it against the piston (12) until the base of cartridge is seated well on the top hook of the trigger (3).

Step 3: Adjust the regulator (4) to position 5. Push the gel bait plunger gently from the base of the cartridge to drive the gel to the outlet, then press repeatedly the trigger until the gel comes out.

Step 4: Now the gun is ready for application.

Step 5: Dial the regulator to the position from 1 to 5 to get the desired dose.

Step 1 ~ 5

(1)

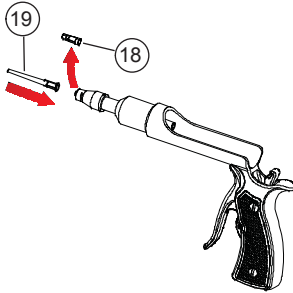

(2)

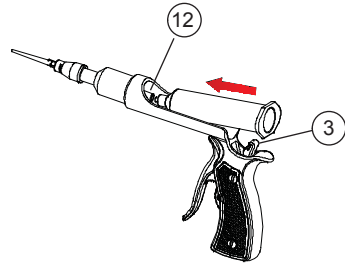

(3)

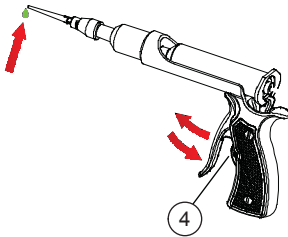

(4)

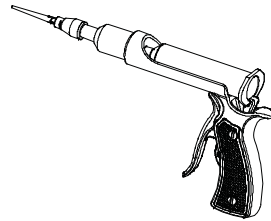

(5)

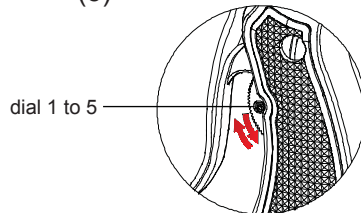

After using

- Take off the needle (19) from the gun, screw back the closure (18) to the gun to prevent the drying of gel at the output.
- Dial the regulator to “0” position to avoid trigger pressing by accident.
- Leave the gel cartridge into the gun compartment to prevent the gel left inside the gun from drying then blocking the piston and other gun parts.
- If necessary, clean the used needles with the cleaning rod.
- Put the gun and parts back into the provided pouch .

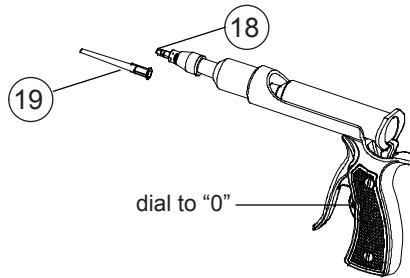

Attention

Dosage performance varies depending on viscosity and density of the gel used. Airofog Gel Gun provides 2 types of wheel regulator - smaller dosage (red) and bigger dosage (black) with a remark of “B” on the wheel. It is recommended to do a test prior to parameterize adjustment.

Airofog Gel Gun is only for gel bait, not for application of high viscosity pastes.

Dosage reference

regulator mark	red (smal)	black (big)
1	0.017g	0.05g
2	0.033g	0.1g
3	0.05g	0.15g
4	0.067g	0.17g
5	0.083g	0.19g

Care and Maintenance

1. As the drying of gel could block the flow for the next use, always leave the gel cartridge inside the compartment after each use or even when the gel is used up but a new cartridge is not replaced yet.
2. Maintenance is not necessary as long as the drying of gel does not happen.
3. The only care to be required is cleaning. All the parts of gun can be soaked and washed in the warm water with detergent.
4. When there is air bubble in the gel cartridge, it may occur that no gel comes out even pulling trigger several times. In this case, just push forward the cartridge from the base by 2 thumbs and repeat this movement, the air bubble will be driven out and regular flow continues. Plunger can do the same job of expelling the air bubble out of the cartridge.

Guarantee

AIROFOG MACHINERY CO., LTD. (called AIROFOG) guarantees Airofog Gel Gun to be free of defects in materials or workmanship to the original purchaser for a period of one (1) year, on labour and parts which are not subject to usual wear.

During this period, AIROFOG will replace and/or repair the parts with material and/or manufacturing faults (on the exclusive judgement of our technical department) free of charge.

The despatch and return expenses will be borne by the customer.

The guarantee does not cover any damage occurred during transport or by incorrect handling, tempering, improper use, the use of non-recommended products and so on.

Under no circumstances will AIROFOG be liable for damages due to improper use or application. Under no circumstances will AIROFOG be responsible for damages done to any property or persons.

Gel Gun

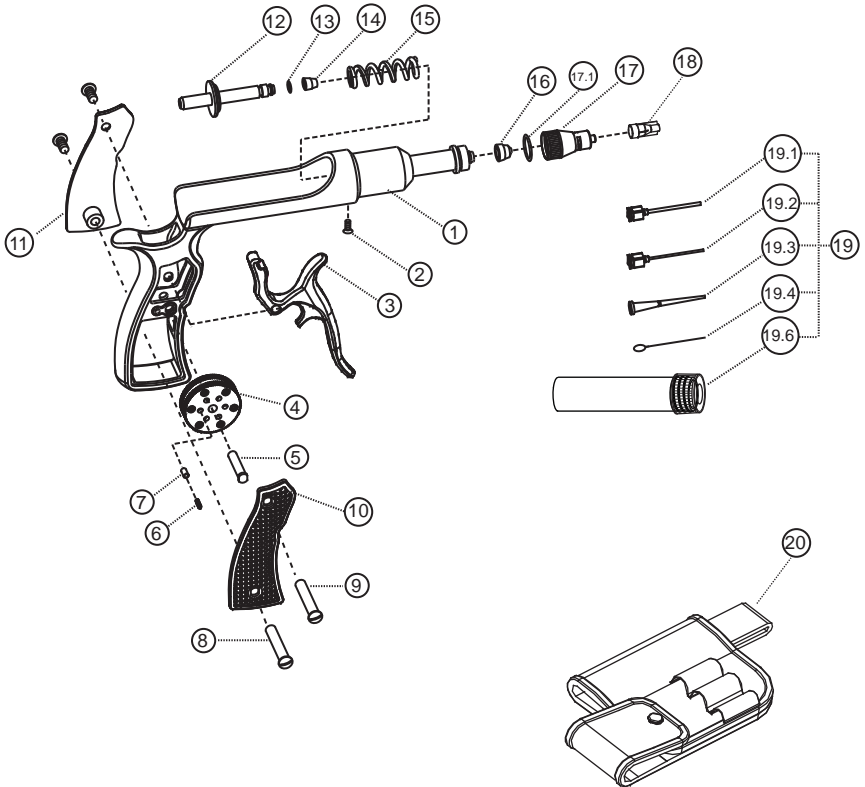

272227

Gel Gun Spare Part List

Pos. no.	Part no.	Description
1	600-001-000	Gun Body
2	260-051-000	Countersunk Screw M3x8
3	600-003-000	Trigger
4	600-004-000	Regulator Small (Red)
4	600-004-020	Regulator Big ("B" Black)
5	600-005-000	Regulator Bolt
6	600-006-000	Spring
7	600-007-000	Spring Seat
8	500-009-070	Cover Bolt
9	600-009-000	Cover Bolt
10	600-010-000	Handle Cup "Right" (Red)
10	600-010-010	Handle Cup "Right" (Black)
11	600-011-000	Handle Cup "Left" (Red)
11	600-011-010	Handle Cup "Left" (Black)
12	600-012-000	Piston
13	500-009-180	O-Ring
14	600-014-000	Inlet Check Valve
15	600-015-000	Positon Spring
16	600-016-000	Outlet Check Valve
17	600-017-000	SafetyLock Adapter
17.1	600-017-010	O-Ring
18	600-018-000	Closure
19	600-019-000	Tip Kit (19.1-19.6)
19.1	600-019-010	S.S.Tip 1.5
	600-019-150	S.S.Tip 1.5x150mm (optional)
19.2	600-019-020	S.S.Tip 1.8
19.3	600-019-030	Plastic Tip
19.4	600-019-040	Cleaning Rod
	600-019-041	Cleaning Rod 150mm (optional)
19.6	602-007-010	Vial with Cap
20	600-024-000	Carrying Case
	600-028-000	Service Kit (13, 14, 16, 17.1)